

Accessories for Lubrication Systems

Product Catalogue



Productivity is key in today's global economy. Proper lubrication increases uptime and makes maintenance routines simple.

Accessories for Lubrication Systems



Our Experience

Lincoln was established in 1910 and is the long-standing world leader in grease lubrication systems and equipment. Decades of business experience have provided us with a high level of expertise and know-how within the lubrication system industry. As a pioneer in the industry, we will continue being a trendsetter confidently providing our customers with the best lubrication system solutions in both price and quality.



Our Service

Our customer service includes the consulting, engineering and planning of customer-oriented systems for all applications, the manufacturing of standard components such as pumps, metering devices or control equipment, the installation and start up of lubrication systems on site in all parts of the world, as well as the customer training, and after-market service.

Our Quality

Our certified Quality Management System according to DIN EN ISO 9001, our expertise, consulting qualities and inventiveness, lead the way for future customer-oriented, economical and intelligent solutions.



Our Product

Lincoln lubrication systems reduce friction and wear; thereby, decreasing maintenance costs, improving productivity, ensuring a higher level of safety and contribution to the environment.

Our Environmental Management System

Our Environmental Management System according to DIN EN ISO 14001 and EMAS, is an integral part of our company philosophy that reflects Lincoln's future orientation.











Our Motto

Keep in motion –
Bleiben Sie mit uns in Bewegung!

Table of Contents

Accessories for Lubrication Systems



Electronic Pressure Switch with Digital Display	4																			
Pressure Gauges, Lubricant Filters	5																			
Solenoid Valves	6																			
Controllers	7																			
Hose, Tube and Fittings	8 - 9																			
Connection Elements Screw-Type, Male Connector GE, Male Elbow WE, Union G, Union T, Reducer KOR/RED	10 - 13																			
Adapter, Connector and Swivel	14 - 15																			
Quicklinc™, Push-in Type	16 - 19																			
Bulkhead Fitting, Clamps	20 - 21																			
Fixing Parts and Items	22																			
Index	23 - 26	<table border="1"> <tr> <td>223-12454-1</td> <td>12</td> <td>223-12533-5</td> </tr> <tr> <td>223-12454-3</td> <td>12</td> <td>223-12533-6</td> </tr> <tr> <td>223-12454-5</td> <td>12</td> <td>223-12533-9</td> </tr> <tr> <td>223-12454-6</td> <td>12</td> <td>223-12563-2</td> </tr> <tr> <td>223-12454-7</td> <td>12</td> <td>223-12563-5</td> </tr> <tr> <td>223-12454-8</td> <td>12</td> <td>223-12563-7</td> </tr> </table>	223-12454-1	12	223-12533-5	223-12454-3	12	223-12533-6	223-12454-5	12	223-12533-9	223-12454-6	12	223-12563-2	223-12454-7	12	223-12563-5	223-12454-8	12	223-12563-7
223-12454-1	12	223-12533-5																		
223-12454-3	12	223-12533-6																		
223-12454-5	12	223-12533-9																		
223-12454-6	12	223-12563-2																		
223-12454-7	12	223-12563-5																		
223-12454-8	12	223-12563-7																		

Electronic Pressure Switch with Digital Display



This pressure switch is equipped with 1 digital display, 2 switching outputs and 1 analog output. The switching point can be adjusted via keys and can be used for pressures between 0 and 400 bar.

Part No.	Description
234-13194-4	electronic pressure switch

Technical Data

Input Data	
measuring range	0–400 bar (0–5800 psi)
overload pressure	600 bar (8700 psi)
burst pressure	300% full scale
Output Data	
accuracy	≥ 0,5% full scale
Analog Output	
signal	4 ... 20 mA, ohms resistance ≥ 500 Ω
Switching Output	
type	PNP-transistor output
switching current	max. 0,7A
life expectancy	≥ 20 million cycles
Other Data	
supply voltage	15 ... 30 VDC
hydraulic connection	G 1/4 male (BSPP)

Dimensions

Height	Depth	Width
112 mm (4.41 in)	35 mm (1.38 in)	42 mm (1.65 in)

Pressure Gauges, Lubricant Filters



Models

Part No.	Description
234-13101-1	0 – 600 bar pressure gauge, dia. 80 mm, G1/2 male (BSPP)
234-13101-2	0 – 600 bar pressure gauge, dia. 100 mm, R1/2 male (BSPT)
234-13101-4	0 – 600 bar pressure gauge, dia. 100 mm, glycol filled, G1/2 (BSPP)
234-13101-5	0 – 250 bar pressure gauge, dia. 100 mm BAR (R1/2)



Pressure Gauge 234-13101-4

These easy to service filters consist of a coarse strainer (410 micron) and a fine strainer (270 micron). They are pressure-

rated for 400 bar (5800 psi) and allow a flow rate of up to 24 liters/hour (6.3 US gal/hour).

Models

Part No.	Description
528-31341-3	filter block with R1/4 female (BSPT)
628-25531-2	filter block with R3/8 female (BSPT)
628-25709-1	double reversible filter block with R3/8 female (BSPT)



Filter Block 628-25531-2

Lubricant filter unit galvanized and chromate-treated, with hydraulic lubrication fitting, for the filling of Quicklub pumps and for upstream

installation in divider valve lubrication systems, outlet connection 1/8" BSP.

Models

Part No.	Description
528-36045-6	lubricant filter unit



Lubricant Filter Unit

The tube filter is an additional protection in application areas where there is contamination.

Models

Part No.	Description	Thread
628-36062-3	SF1-G1/4 + hydraulic lubrication fitting	G 1/4 female
628-26452-2	lubrication filter SF1-G1/4	
428-21544-1	filter	
532-31537-2	hydraulic lubrication fitting	



Tube Filter



Lubricant Solenoid Valves

Lincoln offers a variety of solenoid valves for grease, oil and air.

Lubricant Solenoid Valves

The depicted solenoid valves for grease (or oil) are specially designed to meet the tough requirements of grease lubrication applications.

With conventional valves, the grease has the tendency to harden within the valve, causing blockage.

Technical Data

	2/2 Way	3/2 Way
pressure range	0–400 bar (0–5800 psi)	
flow rate	2,4 liters/min (0.6 US gal/min)	
voltage	24 and 48 VDC, 230/110–120 VAC	

Lubricant Solenoid Valves

Part No.	Type	Off Position	Operating Voltage	Connection Threads Female (BSPP)
525-32080-1	2/2 way valve	normally closed	24 VDC	G 1/2
525-32094-1	2/2 way valve	normally closed	48 VDC	G 1/2
525-32082-1	2/2 way valve	normally closed	230 VAC	G 1/2
525-32081-1	2/2 way valve	normally closed	110 VAC	G 1/2
525-32083-1	2/2 way valve	normally open	24 VDC	G 1/2
525-32093-1	2/2 way valve	normally open	48 VDC	G 1/2
525-32084-1	2/2 way valve	normally open	230 VAC	G 1/2
525-32098-1	2/2 way valve	normally open	110 VAC	G 1/2
525-32085-1	3/2 way valve		24 VDC	G 3/8
525-32096-1	3/2 way valve		48 VDC	G 3/8
525-32087-1	3/2 way valve		230 VAC	G 3/8
525-32086-1	3/2 way valve		110 VAC	G 3/8

Air Solenoid Valves

Part No.	Type	Off Position	Operating Voltage	Connection Threads Female (BSPP)
253-14136-1	2/2 way valve	normally closed	24 VDC	G 3/8
253-14136-2	2/2 way valve	normally closed	48 VDC	G 3/8
253-14136-3	2/2 way valve	normally closed	110 VAC	G 3/8
253-14136-4	2/2 way valve	normally closed	230 VAC	G 3/8
253-14076-6	3/2 way valve		110-120 VAC	G 1/2
253-14076-7	3/2 way valve		230 VAC	G 1/2
253-14263-3	3/2 way valve		24 VDC	G 1/4
235-13148-6	3/2 way valve		24 VDC	G 1/8

Controller for Single-line and Two-line Systems

part no.	664-36957-4
dimensions	75 x 160 x 75 mm
operating voltage	10 to 32 V DC
pause time	1 to 179 min
monitoring time	15 min

Display of high and low levels

For controlling and monitoring purposes pressure switches are required (minimum 1 pressure switch for single-line system, 2 pressure switches for two-line system).



Controller for Single-line and Two-line Systems

Universal Controller with Logic Relay

part no.	1SLO3-00000-00
dimensions	380 x 380 x 210 mm
application	small to medium-sized systems (two-line systems, progressive systems, spray lubrication systems)
input voltage	230 VAC (other voltages available)
inputs	8, two of which may be used analogously
outputs	4

Display and operator keypad (under transparent protection cover), integrated tact generator and counter.



Universal Controller with Logic Relay

Universal Controller with SPS & Text Display

part no.	1SS73-00000-00
dimensions	380 x 380 x 210 mm
application	Medium-size and large systems (two-line systems, progressive systems, spray lubrication systems)
input voltage	230 VAC (other voltages available)
inputs	14, also available with analog inputs
outputs	10
text display	2 lines with 20 characters each

Standard with up to 6 monitored progressive divider valves or nozzles; up to 4 monitored two-line metering devices



Universal Controller with SPS & Text Displays

Universal Controller with Compact SPS

part no.	1SC74-00000-00
dimensions	380 x 380 x 210 mm
application	medium and large-sized systems with a lot of monitoring locations (two-line systems, progressive systems, spray lubrication systems)
input voltage	400 VAC (other voltages available)
inputs	16
outputs	16
text display	2 lines with 20 characters each

Complete unit with display (2 lines with 20 characters each) and ASI-bus expansion module available up to 124 inputs and 124 outputs
Standard with up to 12 monitored progressive divider valves or nozzles; up to 10 monitored two-line metering devices



Universal Controller with Compact SPS

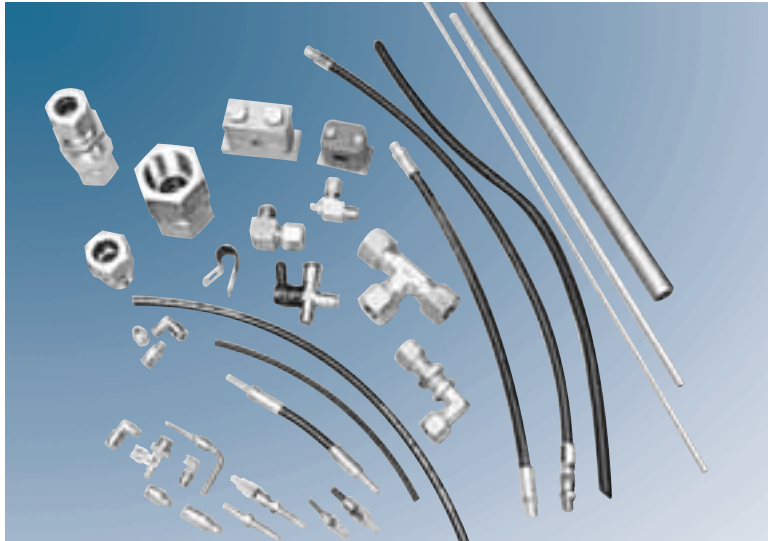

All necessary tubing, hoses, fittings and fastening material are available to meet your system requirements.

Tubes are available in several sizes and materials ranging from steel, stainless steel, and copper to plastic (PA). To save your time when installing your own systems, plastic tubes are even available pre-filled with grease.

Fittings are also available in several sizes, materials and series (light to heavy). For easy installation, we have special Quicklinec push-in type fittings that can be used with plastic tubes.

Popular Hoses and Plastic Tubes

Part No.	Description	Maximum Operating Pressure	Minimum Bursting Pressure (with Hose Coupling, Screwed) at 20° C	Temperature Range	Minimum Bending Radius
504-36033-3 order by meter, max. length 50 meters	high-pressure plastic hose 8.6 X 2.3 mm GREASE-FILLED	350 bar (5075 psi)	600 bar (8700 psi)	-40° C to +70° C (-40° F to 158° F)	35 mm (1.4 in)
504-36041-2 order by meter, max. length 50 meters	pressure plastic tube 6 X 1.5 mm GREASE-FILLED		210 bar (3045 psi)		50 mm (2 in)
111-35114-1 order by meter, max. length 50 meters	high-pressure plastic hose 8.6 X 2.3 mm UNFILLED		600 bar (8700 psi)		35 mm (1.4 in)
112-35127-7 order by meter, max. length 50 meters	pressure plastic tube 4 X 1 mm UNFILLED		210 bar (3045 psi)		50 mm (2 in)
112-35127-2 order by meter, max. length 50 meters	pressure plastic tube 6 X 1.5 mm UNFILLED		210 bar (3045 psi)		50 mm (2 in)

Threaded Sleeves and Hose Studs for High-pressure Plastic Hose

Part No.	Item Standard	Designation	Ø mm
432-23031-1	1	threaded sleeve	
432-24162-1	2	hose stud, short	6
432-23067-1	2	hose stud, long	6
532-30739-1	2	hose stud, 90°, short	6
532-30738-1	2	hose stud, 90°, long	6



Threaded Sleeves and Hose Stud

Part No.	Item Stainless Steel	Designation	Ø mm
432-23676-1	1	threaded sleeve	
432-23675-1	2	hose stud, short	6

Seamless Precision Tubing

Dia. (mm)	Yellow Chromated Steel DIN 2391 ISO 3304	Stainless Steel 1.4571 DIN 2462 ISO 1127	Stainless Steel 1.4301 DIN 2462 ISO 1127	Stainless Steel 1.4541 DIN 2462 ISO 1127	Copper Semi-rigid SfCuF25, DIN 1754
-----------	---	---	---	---	--

Heavy Range: For S Type Fittings

6 x 1	105-35025-2	106-35203-4	106-35231-1	106-35064-4	107-35287-2
10 x 1,5	105-35025-5	106-35203-2	106-35231-3	106-35063-3	107-35045-4
12 x 1,5	105-35134-3	106-35233-9	106-35267-1	106-35063-5	
16 x 2	105-35183-3		106-35231-5		
20 x 2	105-35134-1	106-35203-1	106-35231-6	106-35063-8	107-35045-6
30 x 3	105-35134-4	106-35203-7	106-35231-7	106-35064-9	

Medium to Light Range: For L & LL Fittings

8 x 1	105-35025-3	106-35203-3	106-35231-2	106-35063-1	
15 x 1,5	105-35134-9	106-35233-1	106-35231-4		107-35045-9
22 x 2	105-35251-2	106-35292-2	106-35267-4	106-35064-8	
28 x 2		106-35292-1		106-35285-1	
28 x 3	105-35183-7				

Connecting Elements, Screw-Type

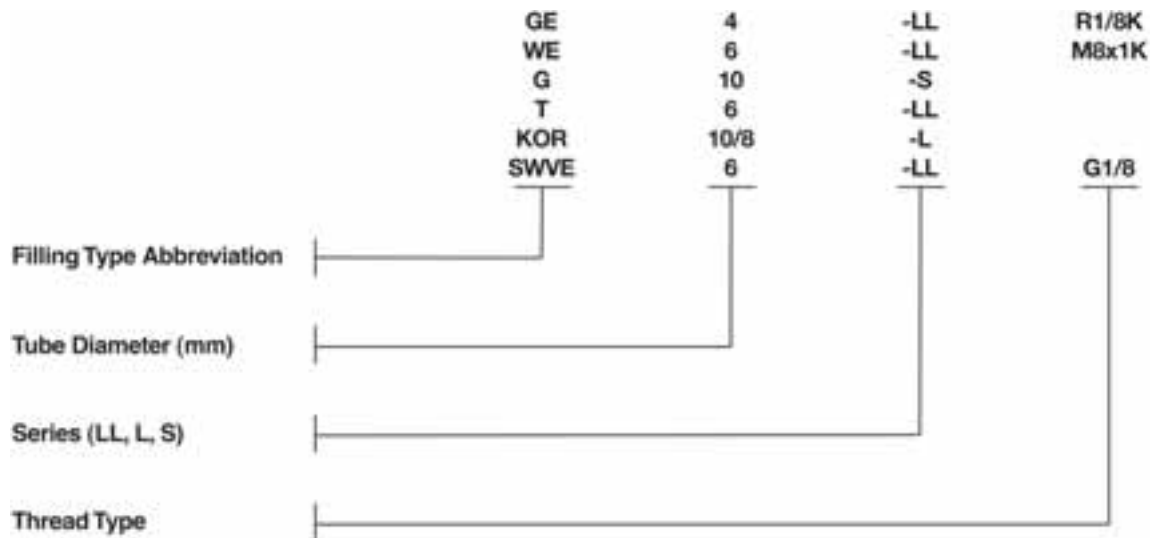

Note: M = metric, R = BSPT, G = BSPP, K = conical

Series LL, L and S Selection

	LL	L		S	
design	very light	light		rigid	
tube diameter (mm)	4, 6, 8, 10, 12	6, 8, 10, 12, 15	22, 28	6, 8, 10, 12	16, 20, 30
nominal pressure	100 bar	315 bar	160 bar	630 bar	400 bar
max. pressure	250 bar	500 bar	250 bar	900 bar	420 bar
space requirement	very small	small		large	
typical application	<ul style="list-style-type: none"> ● lubrication point fittings ● Quicklub systems 			<ul style="list-style-type: none"> ● high-pressure systems ● heavy industry 	

Fitting Type Abbreviation

Type	Description
GE	male connector
WE	male elbow
G	union
T	union T
KOR	reducer
SWVE	connector and swivel

Male Connector GE



Standard Chromate-treated

Model	Part No.
GE4-LL M6x1K	223-12533-5
GE4-LL M8x1K	223-12271-8
GE4-LL M10x1K	223-13069-1
GE4-LL R1/8K	223-12270-8
GE6-LL M6x1K	223-12533-9
GE6-LL M8x1K	223-13023-1
GE6-LL M10x1K	223-12271-7
GE6-LL R1/8K	223-12270-7
GE6-LL 1/8NPT	223-12273-6
GE6-L M10x1	223-12571-2
GE6-L G1/8	223-13016-3
GE6-L G1/4	223-12477-8
GE6-L 1/4NPT	223-13766-2
GE6-S G1/4	223-12477-1
GE8-LL M10x1K	223-13021-1
GE8-LL R1/8K	223-12270-9
GE8-LL R1/4K	223-13621-6
GE8-L M12x1,5K	223-12361-6
GE8-L G1/4	223-12477-6
GE8-L 1/4NPT	223-12273-5
GE8-S G1/4	223-12477-2
GE8-S G3/8	223-13016-6
GE10-L G1/8	223-13621-9
GE10-L G1/4	223-12272-9
GE10-S 1/8NPT	223-13096-3
GE10-S G1/4	223-13016-9
GE10-S 1/4NPT	223-13096-2
GE10-S G1/2	223-13621-7
GE10-S G3/8	223-13016-4
GE10-S 3/8NPT	223-13096-6
GE12-L G3/8	223-12360-8
GE12-L 3/8NPT	223-13621-3
GE12-S G3/8	223-13016-7

Model	Part No.
GE15-L G3/8A	223-13621-8
GE16-S G3/8	223-13749-5
GE16-S G1/2	223-13621-1
GE20-S G1/2	223-12360-6
GE20-S G3/4	223-12359-6
GE22-L G1/2	223-13749-3
GE22-L G3/4	223-13016-2
GE30-S G1	223-13749-8
GE30-S G1-1/4	223-12360-2

High-grade Stainless Steel (1.4571)

Model	Part No.
GE4-LL M6x1K	223-13784-9
GE4-LL R1/8K	223-13614-8
GE4-LL 1/8NPT	223-13715-4
GE6-LL M6x1	223-13658-7
GE6-LL M8x1	223-13658-6
GE6-LL M10x1	223-13658-5
GE6-LL R1/8	223-13614-9
GE6-L G1/8	223-13658-2
GE6-L 1/8NPT	223-13784-2
GE6-L G1/4	223-13658-9
GE6-L 1/8NPT	223-13784-2
GE6-L G1/4	223-13658-9
GE8-LL G1/8	223-13658-1
GE8-L G1/4	223-12452-3
GE10-L G1/8	223-13658-8
GE10-L G1/4	223-12452-1
GE10-L 1/4NPT	223-13614-2
GE10-S G1/4	223-12452-9
GE10-S G3/8	223-12452-2
GE16-S G1/2	223-12452-7
GE20-S G3/4	223-12452-5
GE20-S G1/2	223-13658-4
GE22-L R3/4K	223-13784-5



Male Connector

Brass

Model	Part No.
GE4-LL R1/8K	223-12375-1
GE8-LL M10x1K	223-12376-3
GE8-L G1/4	223-12377-7
GE8-L 1/4NPT	223-13769-2
GE8-L G1/8	223-13769-4
GE10-L G1/4	223-12377-4
GE15-L G1/2	223-12377-8
GE20-S G1/2	223-12378-4
GE20-S G3/4	223-12377-9

Male Elbow WE Union G



Male Elbow

Standard Chromate-treated

Model	Part No.
WE4-LL M 6x1K	223-12533-6
WE4-LL M 8x1K	223-13021-5
WE4-LL M10x1K	223-13069-2
WE4-LL R1/8K	223-13021-4
WE6-LL M 6x1K	223-13023-2
WE6-LL M 8x1K	223-13023-3
WE6-LL M 8x1,25K	223-13763-4
WE6-LL M10x1K	223-13021-3
WE6-LL R1/8K	223-12485-9
WE6-LL 1/8NPT	223-13620-4
WE6-L R1/8K	223-13048-1
WE6-L R1/4K	223-12380-6
WE8-LL M10x1K	223-12362-4
WE8-LL R1/8K	223-13021-6
WE8-L M12x1,5K	223-12362-8
WE8-S R1/4K	223-13048-4
WE10-L R1/4K	223-13048-5
WE10-S R3/8K	223-13048-6
WE20-S G3/4A	223-12277-2
WE20-S 3/4NPT	223-13620-2

High-grade Stainless Steel (1.4571)

Model	Part No.
WE4-LL R1/8K	223-13677-8
WE6-LL M6x K	223-13677-4
WE6-LL M 6x1K (short thread)	223-14181-1
WE6-LL M8x1K	223-13677-2
WE6-LL M10x1K	223-13677-3
WE6-LL R1/8K	223-12453-7
WE6-L R1/8K	223-13620-8
WE6-L R1/4K	223-13794-1
WE6-L 1/4NPT	223-13677-9
WE6-S R1/4K	223-13620-1
WE8-LL R1/8K	223-13677-1
WE8-L R1/4K	223-13677-5
WE10-L R1/4K	223-12453-1

Standard Chromate-treated

Model	Part No.
G4-LL	223-12531-8
G6-LL	223-12482-9
G6-L	223-12482-2
G6-S	223-13049-1
G8-L	223-12482-6
G10-L	223-12531-2
G10-S	223-13049-3
G12-S	223-12278-9
G15-L	223-12531-6
G16-S	223-12531-4
G20-S	223-12363-2
G22-L	223-13049-7
G30-S	223-12363-6

High-grade Stainless Steel (1.4571)

Model	Part No.
G6-LL	223-12454-7
G8-L	223-13615-3
G10-L	223-13615-6
G10-S	223-12454-1
G12-S	223-13615-7
G15-L	223-12454-8
G16-S	223-12454-6
G20-S	223-12454-3
G22-L	223-13615-8
G30S	223-12454-5



Union

Brass

Model	Part No.
G6-L	223-12381-7
G8-L	223-12381-8
G10-L	223-13767-2
G10-S	223-12381-4
G15-L	223-12381-9
G20-S	223-12381-6

Union-Tee T Reducer KOR/RED



Standard Chromate-treated

Model	Part No.
T4-LL	223-12563-5
T6-LL	223-12484-9
T6-L	223-12484-2
T6-S	223-12563-7
T8-L	223-12484-6
T10-L	223-13057-5
T10-S	223-12563-9
T12-S	223-12281-9
T15-L	223-12563-2
T16-S	223-13057-2
T20-S	223-12366-2
T22-L	223-13057-4
T30-S	223-12366-6

High-grade Stainless Steel (1.4571)

Model	Part No.
T6-LL	223-10083-1
T6-L	223-12455-7
T6-S	223-13616-8
T8-L	223-12455-3
T10-L	223-13616-3
T10-S	223-12455-1
T12-S	223-12455-9
T15-L	223-13616-4
T16-S	223-12455-5
T20-S	223-12455-2
T22-L	223-13616-6
T30-S	223-12455-4



Union-Tee

Brass

Model	Part No.
T6-S	223-12384-2
T8-L	223-12384-6
T10-L	223-13792-1
T10-S	223-12384-4
T15-L	223-12384-8
T20-S	223-12384-7



Reducer

Standard Chromate-treated

Model	Part No.
RED10/6-L	223-10187-1
RED12/10-L	223-14293-2
RED15/8-L	223-14152-2
RED16/10-S	223-14293-1
RED20/10-S	223-12577-2
RED22/10-L	223-13759-8
RED25/10-S	223-12580-6
RED25/20-S	223-14293-3

High-grade Stainless Steel (1.4571/316Ti)

Model	Part No.
RED10/6-L	223-10040-1
RED12/10-S	223-14413-9
RED16/10-S	223-14297-1
RED20/10-S	223-14297-7
RED22/10-L	223-14297-9
RED30/10-S	223-14413-3

Brass

Model	Part No.
KOR15/8-L	223-13759-5
KOR15/10-L	223-12582-7
KOR20/10-S	223-13759-4

Reducer KOR/RED

These fittings are used to reduce from one size of tubing to a smaller size. KOR/RED fittings must be used in conjunction with the larger size G or T fittings. E.g. to reduce from 20 to 10 mm tube, use a G20-S and a RED20/10-S.



Adapter

Adapter

Thread, Female	Thread, Male	Part No.
M 8 x 1	M 6 x 1 K	304-19787-1
M 8 x 1	M 8 x 1 K	304-19437-1
M 10 x 1	M 10 x 1 K	304-19509-1
M 10 x 1	R 1/8 K	304-19230-1
M 10 x 1	M 12x1 K	712-12724-7
R 1/8 M	8x1 K	304-19167-1
1/8 NPT R _		304-17582-1
_ NPT R 1/4		304-17581-1
R 1/2 R _		304-17564-1



Adapter 90°

Adapter 90°

Thread, Female	Thread, Male	Part No.
M 8 x 1 K	M 8 x 1	432-24043-1
M 10 x 1 K	M 8 x 1	432-24052-1

Note: When screwing in a threaded fitting take care that the outlet borehole of the elbow fittings is not closed by the threaded piece of the inlet fitting.



Adapter 45°

Adapter 45°

Thread, Female	Thread, Male	Part No.
M 8 x 1	M 8 x 1	432-24050-1
M 10 x 1	M 8 x 1	432-24051-1

Note: When screwing in a threaded fitting take care that the outlet borehole of the elbow fittings is not closed by the threaded piece of the inlet fitting.

Connector and Swivel



Banjo Connector

Model	Tube Diameter	Part No.
SWVE4-LL G1/8	4 mm	223-13629-1
SWVE4-LL M10x1	4 mm	223-12480-8
SWVE6-LL G1/8	6 mm	223-12479-9
SWVE6-LL M10x1	6 mm	223-12480-7
SWVE8-LL G1/8	8 mm	223-12479-8
SWVE8-S G1/4	8 mm	223-12285-9
SWVE10-L G1/4	10 mm	223-12369-9
SWVE10-S G3/8	10 mm	223-12285-5



Banjo Connector

Straight Swivel

Model	Part No.
1/8 i x 1/8 a NPT	223-12567-3

Note: To be used only for occasional rotary motions.



Straight Swivel

90° Angle Swivel

Model	Part No.
1/8 i x 1/8 a NPT	223-12567-1

Note: To be used only for occasional rotary motions.



90° Angle Swivel

90° Angle Swivel with 1 Swivel Section, Galvanized and Chromate-treated

Connections	Part No.
1/4" BSP x 1/4" BSP	626-25716-2
1/4" BSP x 1/8" BSP	626-25540-2
1/8" BSP x tubing O.D. 4 mm	626-26700-2
1/8" BSP x tubing O.D. 6 mm	626-25438-2
1/4" BSP x tubing O.D. 6 mm	626-25717-2



90° Angle Swivel
626-25438-2

Technical Data

max. permissible speed	800 rpm
max. permissible pressure	100 bar (1450 psig)

Quicklinc™, Push-in Type



Installing lubrication systems can take a lot of time, especially when there's not much space to work with. Those problems are a thing of the past with Quicklinc™ "push-in" fittings. Great for hard-to-reach places, Quicklinc™ can cut the time it takes to install line connections in half – or more – when compared to screw-type connectors, which require the assembly of four components.

Quicklinc™ fittings from Lincoln are designed for high pressure, withstanding up to 350 bar (reinforced collar version). They are used primarily in progressive systems from the pump to the main metering device (reinforced collar version) and from the main to secondary metering devices or lube points (knurled collar version).

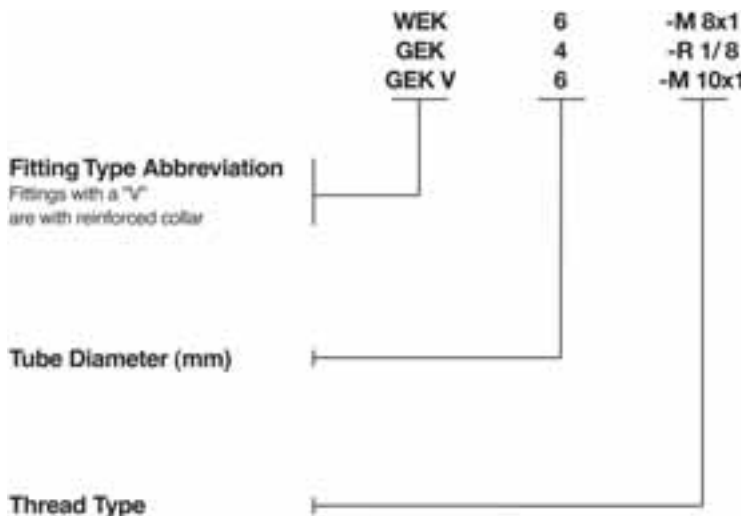

Note: M = metric, R = BSPT, G = GSPP, K = conical



Male Connector with Knurled Collar

Male Connector, Push-in Type

Design with Knurled Collar

Model	Tube Diameter	Part No.
GEK4-M 6 x 1	4 mm	226-13752-3
GEK4-M 8 x 1	4 mm	226-13752-1
GEK4-M 10 x 1	4 mm	226-13752-2
GEK4-1/8	4 mm	226-13752-4
GEK6-M 6 x 1	6 mm	226-13752-8
GEK6-M 8 x 1	6 mm	226-13752-7
GEK6-M 10 x 1	6 mm	226-13752-6
GEK6-1/8	6 mm	226-13752-9



Male Connector with Reinforced Collar

Male Connector, Push-in Type

Design with Reinforced Collar

Model	Tube Diameter	Part No.
GEKV-6-M 6 x 1	6 mm	226-14111-4
GEKV-6-M 8 x 1	6 mm	226-14111-2
GEKV-6-M 10 x 1	6 mm	226-14111-3
GEKV-6-1/8	6 mm	226-14111-1

Important: Use this fitting only for the connection of the lubrication points, if the pressure plastic tube (6 x 1,5 mm) will be replaced by high-pressure plastic hose (8.6 x 2.3 mm).

Elbow, Push-in Type

Design with Knurled Collar

Model	Tube Diameter	Part No.
WEK4-M 6 x 1	4 mm	226-13753-5
WEK4-M 8 x 1	4 mm	226-13753-1
WEK4-M 10 x 1	4 mm	226-13753-2
WEK4-1/8	4 mm	226-13753-3
WEK6-M 6 x 1	6 mm	226-13753-7
WEK6-M 8 x 1	6 mm	226-13753-8
WEK6-M 10 x 1	6 mm	226-13753-6
WEK6-1/8	6 mm	226-13753-4



Elbow, Push-in Type, with Knurled Collar

Elbow, Push-in Type

Design with Reinforced Collar

Model	Tube Diameter	Part No.
WEKV6-M 6 x 1	6 mm	226-14123-4
WEKV6-M 8 x 1	6 mm	226-14123-2
WEKV6-M 10 x 1	6 mm	226-14123-3
WEKV6-1/8	6 mm	226-14123-5

Important: Use this fitting only for the connection of the lubrication points, if the pressure plastic tube (Ø 6 x 1.5 mm) will be replaced by high-pressure plastic hose (Ø 8.6 x 2.3 mm).



Elbow, Push-in Type, with Reinforced Collar

Male Elbow, Push-in Type, Rotatable

Design with Knurled Collar

Model	Tube Diameter	Part No.
WEDK4-M 6 x 1	4 mm	226-13756-6
WEDK4-M 8 x 1	4 mm	226-13756-1
WEDK4-M 10 x 1	4 mm	226-13756-2
WEDK4-M 1/8"	4 mm	226-13756-3
WEDK6-M 6 x 1	6 mm	226-13756-7
WEDK6-M 8 x 1	6 mm	226-13756-4
WEDK6-M 10 x 1	6 mm	226-13756-5
WEDK6-1/8	6 mm	226-13756-8

Note: Use only for occasional rotary motions, pivoting angle < 180°. For other applications use a straight rotary swivel, 90° or a similar fitting.



Elbow, Push-in Type, Rotatable, with Knurled Collar

Male Elbow, Push-in Type, Rotatable

Design with Reinforced Collar

Model	Tube Diameter	Part No.
WEDKV6-1/8	6 mm	226-13756-9
WEDKV6-M 10 x 1	6 mm	226-14157-2
WEDKV6-M 8 x 1	6 mm	226-14157-1
WEDKV6-M 6 x 1	6 mm	226-14157-3

Important: Use this fitting only for the connection of the lubrication points, if the pressure plastic tube (6 x 1.5 mm) will be replaced by high-pressure plastic hose (8.6 x 2.3 mm).



Elbow, Push-in Type, Rotatable, with Reinforced Collar



Banjo Connector

Banjo Connector

Design with Knurled Collar

Model	Tube Diameter	Part No.
SWVZ 6-1/8	6 mm	504-36893-1



T-Piece, Push-in Type Reinforced

T-Piece, Push-in Type

Reinforced

Model	Tube Diameter	Part No.
TSV6	6 mm	226-14097-4

Note: Use only for combining two lubricant quantities, either from the main metering device to a secondary metering device or back to the pump. Designed for high-pressure plastic hose (8.6 x 2.3 mm) with hose stud and groove.



T-Piece, Push-in Type, with Knurled Collar

T-Piece, Push-in Type

Design with Knurled Collar

Model	Tube Diameter	Part No.
TS6	6 mm	226-14097-2

Note: Use only for combining two lubricant quantities. Designed for pressure plastic tube (6 x 1.5 mm) for the connection from a secondary metering device to a lubrication point.

Quickline™, Push-in Type



Line Connector Union, Push-in Type

The Quickline™ line connector union is a great way to connect two lines or to fix a broken line without replacing the whole line.

Just clean the line ends, plug them into the connector and the line is repaired.

Model	Part No.
GS4 for pressure plastic tube 4 x 1 mm	226-13773-1
GS6 for pressure plastic tube 6 x 1.5 mm	226-13773-3
GSV6 for high-pressure plastic hose (8.6 x 2.3 mm), with hose stud and groove	226-13773-4

Note: To be used for the repair of high-pressure plastic hose and pressure plastic hose.



Line Connector Union, Push-in Type

Line Connector, Push-in Type

Design with Knurled Collar

Model	Part No.
D 6 x 1.5 for high-pressure plastic hose (8.6 x 2.3 mm), with hose stud and groove	432-24280-1

Note: Use in conjunction with T-piece 226-14097-4.

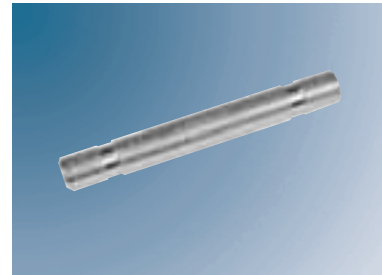

Line Connector, Push-in Type

Protecting Cap for Push-in Type Fittings

Part No.
432-24313-1

Note: For the protection against humidity and dirt.



Protection Cap

Closure Plug

Part No.	Dia. mm
226-13797-3	D 6

Note: For closing the return line connection on the pump.



Closure Plug



Bulkhead Fitting Straight

Straight: SV Standard Chromate-treated

Model	Part No.
SV6-LC	223-12368-4
SV8-LC	223-12368-6
SV10-LC	223-12368-8
SV10-SC	223-12364-6
SV20-SC	223-12368-2

Straight: SV High-grade Stainless Steel (1.4571)

Model	Part No.
SV6-L	223-13671-6
SV8-S	223-13671-9
SV10-S	223-12564-3
SV20-S	223-13671-2

Elbow: WSV Standard Chromate-treated

Model	Part No.
WSV6-L	223-13050-4
WSV8-S	223-13050-1
WSV10-S	223-12050-2
WSV20-S	223-12409-2

Elbow: WSV High-grade Stainless Steel (1.4571)

Model	Part No.
WSV6-L	223-13758-8
WSV10-L	223-13758-7
WSV20-S	223-13758-4

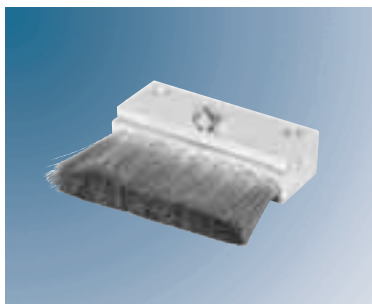

Oilbrush 233-14419-1

Oilbrush

Part No.	Size (L x W)	Inlet	Material of Bristles
68874	45 x 20 mm (1.77 x 0.79 in.)	1/8" NPT female	nylon, ø 16 mm (0,63 in.)
233-13651-1	47 x 17 mm (1.85 x 0.67 in.)	R 1/8" female	brass, ø 20 mm (0,79 in.)
233-13651-6	53 x 16 mm (2.09 x 0.63 in.)	G 1/8" female	stainless steel
233-13651-9	70 x 25 mm (2.76 x 0.99 in.)	G 1/8" female	stainless steel
233-14419-1	50 x 57 mm (1.97 x 2.24 in.)	G 1/8" female	bronze

Tube Clamps

No. Tubes	Tube Diameter	Part No.
1	6 mm	226-12336-1
2	6 mm	226-12336-2
3	6 mm	226-12336-3
4	6 mm	226-12336-4
1	8 mm	226-12337-1
2	8 mm	226-12337-2
3	8 mm	226-12337-3
4	8 mm	226-12337-4
1	10 mm	226-12338-1
2	10 mm	226-12338-2
3	10 mm	226-12338-3
4	10 mm	226-12338-4

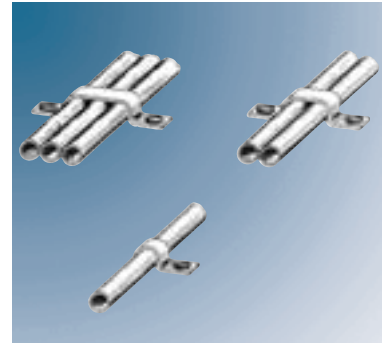

Tube Clamps

Self-tapping Screws

Tube Clamp	Dimension	Part No.
ø 6	M 4 x 8	206-12123-3
ø 8 a 10	BM 6 x 12	206-12125-3

Pipe Clamps Polypropylene (PP) with Welding Plates Standard Range

Designation	Pipe Diameter	Part No.
SP 110 PP-LI	10 mm	226-12343-5
SP 320 PP-LI	20 mm	226-12343-1
SP 320/20 PP-GD-AS	2 x 20 mm	226-13097-3
SP 430 PP-LI	30 mm	226-12343-2



Pipe Clamp, PP

Heavy Duty Range

Designation	Pipe Diameter	Part No.
SPAL 4020 PP DPAL-AS	20 mm	226-13058-3
SPAL 5030 PP DPAL-AS	30 mm	226-13058-5

Tube Clamp with Rubber Lining

Fixing Borehole	Tube Diameter	Part No.
5.5 mm	6 mm	226-12557-1
5.5 mm	9 mm	226-12557-2
5.5 mm	10 mm	226-12557-7
5.5 mm	12 mm	226-12557-3
5.5 mm	15 mm	226-12557-4
5.5 mm	20 mm	226-12557-6



Tube Clamps with Rubber Lining

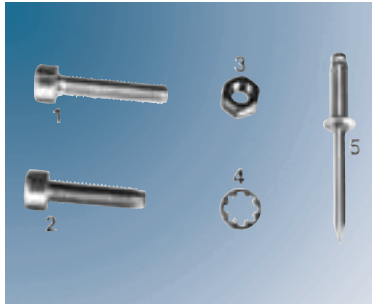

Fixing Part

Fixing Parts for Tube Clamp

Item	Designation	Dimension	Part No.
1	pan head screw	AM 5 x 16 C	201-12040-7
	hexagone head screw	M 5 x 45 C	200-13017-5
2	self-tapping screw	EM 5 x 16 Z	201-13710-1
		CM 5 x 40 Z	206-13710-5
3	nut	M 5 C	207-12138-2
4	tooth lock washer	J 5.3 Z	210-12161-9
5	blind rivet	D 4 x 12	205-12584-1



Plastic Helix

Plastic Helix

The plastic helix is used to bundle several tubes together. It also protects the tubes against wearing in the case of moving lubrication points.

Diameter	Part No.
6 mm	113-35075-2
12 mm	113-35075-3



Hose Strap

Hose Strap

Designation	Part No.
short	226-12490-3
long	226-13095-1

Index



Accessories for Lubrication Systems

Part No.	Page	Part No.	Page	Part No.	Page
105-35025-2	9	107-35045-4	9	223-12285-5	15
105-35025-3	9	107-35045-6	9	223-12285-9	15
105-35025-5	9	107-35045-9	9	223-12359-6	11
105-35134-1	9	107-35287-2	9	223-12360-2	11
105-35134-3	9	111-35114-1	8	223-12360-6	11
105-35134-4	9	112-35127-2	8	223-12360-8	11
105-35134-9	9	112-35127-7	8	223-12361-6	11
105-35183-3	9	113-35075-2	22	223-12362-4	12
105-35183-7	9	113-35075-3	22	223-12362-8	12
105-35251-2	9	1SC74-00000-00	7	223-12363-2	12
106-35063-1	9	1SLO3-00000-00	7	223-12363-6	12
106-35063-3	9	1SS73-00000-00	7	223-12564-6	20
106-35063-5	9	200-13017-5	22	223-12366-2	13
106-35063-8	9	201-12040-7	22	223-12366-6	13
106-35064-4	9	201-13710-1	22	223-12368-2	20
106-35064-8	9	205-12584-1	22	223-12368-4	20
106-35064-9	9	206-12123-3	21	223-12368-6	20
106-35203-1	9	206-12125-3	21	223-12368-8	20
106-35203-2	9	206-13710-5	22	223-12369-9	15
106-35203-3	9	207-12138-2	22	223-12375-1	11
106-35203-4	9	210-12161-9	22	223-12376-3	11
106-35203-7	9	223-10040-1	13	223-12377-4	11
106-35231-1	9	223-10083-1	13	223-12377-7	11
106-35231-2	9	223-10187-1	13	223-12377-8	11
106-35231-3	9	223-12050-2	20	223-12377-9	11
106-35231-4	9	223-12270-7	11	223-12378-4	11
106-35231-5	9	223-12270-8	11	223-12380-6	12
106-35231-6	9	223-12270-9	11	223-12381-4	12
106-35231-7	9	223-12271-7	11	223-12381-6	12
106-35233-1	9	223-12271-8	11	223-12381-7	12
106-35233-9	9	223-12272-9	11	223-12381-8	12
106-35267-1	9	223-12273-5	11	223-12381-9	12
106-35267-4	9	223-12273-6	11	223-12384-2	13
106-35285-1	9	223-12277-2	12	223-12384-4	13
106-35292-1	9	223-12278-9	12	223-12384-6	13
106-35292-2	9	223-12281-9	13	223-12384-7	13

Index



Accessories for Lubrication Systems

Part No.	Page	Part No.	Page	Part No.	Page
223-12384-8	13	223-12484-2	13	223-13023-2	12
223-12409-2	20	223-12484-6	13	223-13023-3	12
223-12452-1	11	223-12484-9	13	223-13048-1	12
223-12452-2	11	223-12485-9	12	223-13048-4	12
223-12452-3	11	223-12531-2	12	223-13048-5	12
223-12452-5	11	223-12531-4	12	223-13048-6	12
223-12452-7	11	223-12531-6	12	223-13049-1	12
223-12452-9	11	223-12531-8	12	223-13049-3	12
223-12453-1	12	223-12533-5	11	223-13049-7	12
223-12453-7	12	223-12533-6	12	223-13050-1	20
223-12454-1	12	223-12533-9	11	223-13050-4	20
223-12454-3	12	223-12563-2	13	223-13057-2	13
223-12454-5	12	223-12563-5	13	223-13057-4	13
223-12454-6	12	223-12563-7	13	223-13057-5	13
223-12454-7	12	223-12563-9	13	223-13069-1	11
223-12454-8	12	223-12564-3	20	223-13069-2	12
223-12455-1	13	223-12567-1	15	223-13096-2	11
223-12455-2	13	223-12567-3	15	223-13096-3	11
223-12455-3	13	223-12571-2	11	223-13096-6	11
223-12455-4	13	223-12577-2	13	223-13614-2	11
223-12455-5	13	223-12580-6	13	223-13614-8	11
223-12455-7	13	223-12582-7	13	223-13614-9	11
223-12455-9	13	223-13016-2	11	223-13615-3	12
223-12477-1	11	223-13016-3	11	223-13615-6	12
223-12477-2	11	223-13016-4	11	223-13615-7	12
223-12477-6	11	223-13016-6	11	223-13615-8	12
223-12477-8	11	223-13016-7	11	223-13616-3	13
223-12479-8	15	223-13016-9	11	223-13616-4	13
223-12479-9	15	223-13021-1	11	223-13616-6	13
223-12480-7	15	223-13021-3	12	223-13616-8	13
223-12480-8	15	223-13021-4	12	223-13620-1	12
223-12482-2	12	223-13021-5	12	223-13620-2	12
223-12482-6	12	223-13021-6	12	223-13620-4	12
223-12482-9	12	223-13023-1	11	223-13620-8	12

Index



Accessories for Lubrication Systems

Part No.	Page	Part No.	Page	Part No.	Page
223-13621-1	11	223-13759-8	13	226-12343-2	21
223-13621-3	11	223-13763-4	12	226-12343-5	21
223-13621-6	11	223-13766-2	11	226-12490-3	22
223-13621-7	11	223-13767-2	12	226-12557-1	21
223-13621-8	11	223-13769-2	11	226-12557-2	21
223-13621-9	11	223-13769-4	11	226-12557-3	21
223-13629-1	15	223-13784-2	11	226-12557-4	21
223-13658-1	11	223-13784-5	11	226-12557-6	21
223-13658-2	11	223-13784-9	11	226-12557-7	21
223-13658-4	11	223-13792-1	13	226-13058-3	21
223-13658-5	11	223-13794-1	12	226-13058-5	21
223-13658-6	11	223-14152-2	13	226-13095-1	22
223-13658-7	11	223-14181-1	12	226-13097-3	21
223-13658-8	11	223-14293-1	13	226-13752-1	16
223-13658-9	11	223-14293-2	13	226-13752-2	16
223-13671-2	20	223-14293-3	13	226-13752-3	16
223-13671-6	20	223-14297-1	13	226-13752-4	16
223-13671-9	20	223-14297-7	13	226-13752-6	16
223-13677-1	12	223-14297-9	13	226-13752-7	16
223-13677-2	12	223-14413-3	13	226-13752-8	16
223-13677-3	12	223-14413-9	13	226-13752-9	16
223-13677-4	12	226-12336-1	21	226-13753-1	17
223-13677-5	12	226-12336-2	21	226-13753-2	17
223-13677-8	12	226-12336-3	21	226-13753-3	17
223-13677-9	12	226-12336-4	21	226-13753-4	17
223-13715-4	11	226-12337-1	21	226-13753-5	17
223-13749-3	11	226-12337-2	21	226-13753-6	17
223-13749-5	11	226-12337-3	21	226-13753-7	17
223-13749-8	11	226-12337-4	21	226-13753-8	17
223-13758-4	20	226-12338-1	21	226-13756-1	17
223-13758-7	20	226-12338-2	21	226-13756-2	17
223-13758-8	20	226-12338-3	21	226-13756-3	17
223-13759-4	13	226-12338-4	21	226-13756-4	17
223-13759-5	13	226-12343-1	25	226-13756-5	17

Index



Accessories for Lubrication Systems

Part No.	Page	Part No.	Page	Part No.	Page
226-13756-6	17	253-14076-7	6	525-32083-1	6
226-13756-7	17	253-14136-1	6	525-32084-1	6
226-13756-8	17	253-14136-2	6	525-32085-1	6
226-13756-9	17	253-14136-3	6	525-32086-1	6
226-13773-1	19	253-14136-4	6	525-32087-1	6
226-13773-3	19	253-14263-3	6	525-32093-1	6
226-13773-4	19	304-17564-1	14	525-32094-1	6
226-13797-3	19	304-17581-1	14	525-32096-1	6
226-14097-2	18	304-17582-1	14	525-32098-1	6
226-14097-4	18	304-19167-1	14	528-31341-3	5
226-14111-1	16	304-19230-1	14	528-36045-6	5
226-14111-2	16	304-19437-1	14	532-30738-1	9
226-14111-3	16	304-19509-1	14	532-30739-1	9
226-14111-4	16	304-19787-1	14	532-31537-2	5
226-14123-2	17	428-21544-1	5	626-25438-2	15
226-14123-3	17	432-23031-1	9	626-25540-2	15
226-14123-4	17	432-23067-1	9	626-25716-2	15
226-14123-5	17	432-23675-1	9	626-25717-2	15
226-14157-1	17	432-23676-1	9	626-26700-2	15
226-14157-2	17	432-24043-1	14	628-25531-2	5
226-14157-3	17	432-24050-1	14	628-25709-1	5
233-13651-1	20	432-24051-1	14	628-26452-2	5
233-13651-6	20	432-24052-1	14	628-36062-3	5
233-13651-9	20	432-24162-1	9	664-36957-4	7
233-14419-1	20	432-24280-1	19	68874	20
234-13101-1	5	432-24313-1	19	712-12724-7	14
234-13101-2	5	504-36033-3	8		
234-13101-4	5	504-36041-2	8		
234-13101-5	5	504-36893-1	18		
234-13194-4	4	525-32080-1	6		
235-13148-6	6	525-32081-1	6		
253-14076-6	6	525-32082-1	6		

Information Is Key to Productivity



Productivity is key in today's global economy. Lincoln – the leader in knowledge, technology and service for lubrication systems – is key to your Total Productivity Maintenance System.

Now you got our catalogue about "Accessories for Lubrication Systems". Other Lincoln catalogues, brochures, owner manuals and technical information are available at your local Lincoln office, distributor or sales agency, or at Lincoln GmbH & Co. KG, Walldorf, Germany (see address on last page).

For more information just get in touch – phone, fax, or click: www.lincolnindustrial.de
CONTACTS
to find your nearest Lincoln representative.

You know: Information is key to your productivity.

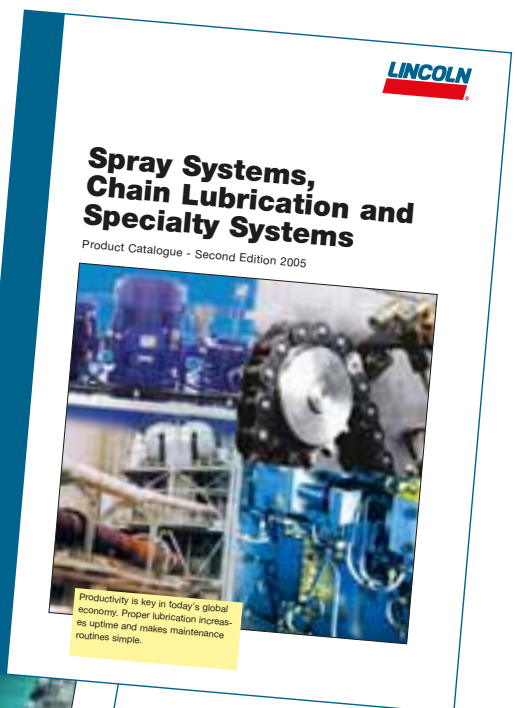

Lincoln's Global Distribution and Service Network

The best in our Industry

Hundreds of Lincoln System Houses are available for you – worldwide

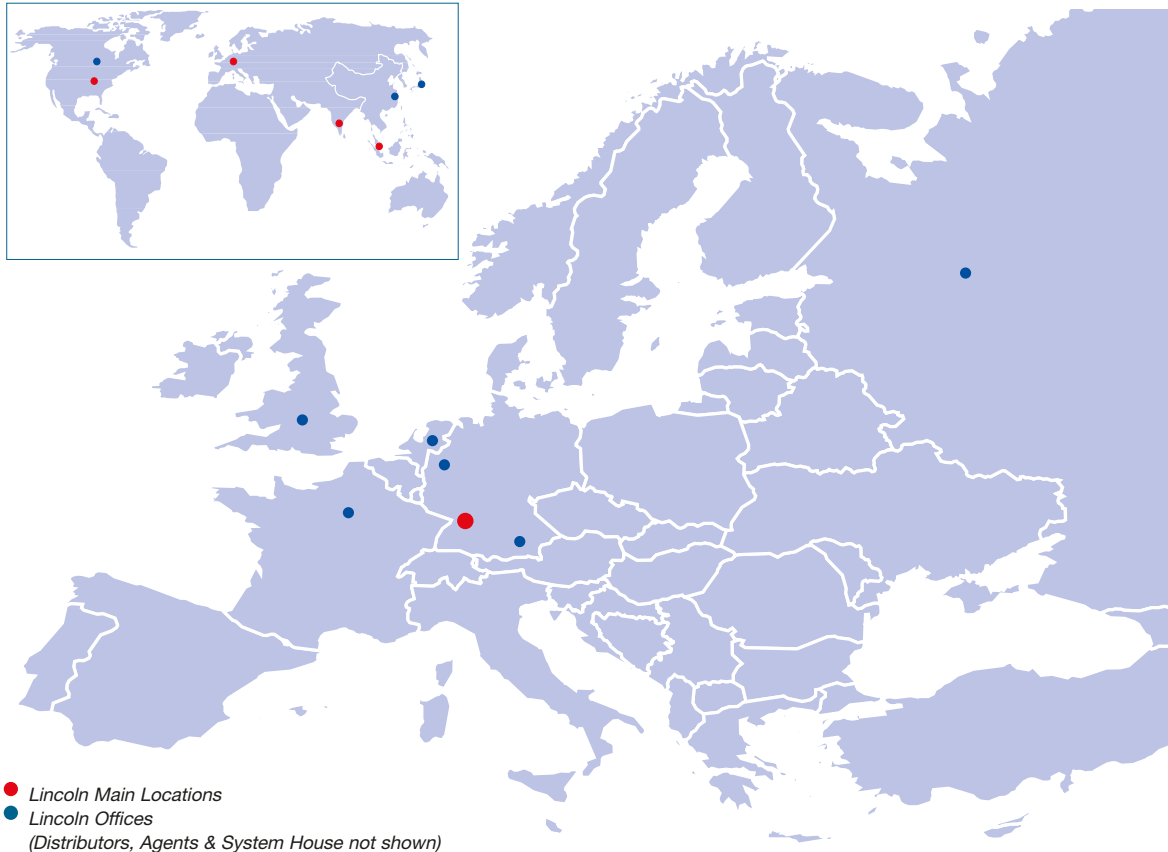

In all levels of service – lubrication system selection & evaluation, custom-engineered system installation, or the supply of top-quality products – the employees of our Lincoln locations, offices, agents and distributors make certain you always get the very best value.

System House Distributors

Our system house distributors offer the highest level of expertise available in the industry. They custom-design systems with the exact combination of Lincoln components you need.

Then they install the system at your facility with experienced technicians or work with your personnel to ensure the job is done correctly. Each distributor stocks a full inventory of pumps, metering devices, controllers and accessories. Each continues to meet our stringent requirements for product, systems and service knowledge. From St. Louis to Singapore, Walldorf and worldwide, Lincoln's top-of-the-industry system house distributors will be there when and where you require them.

For the nearest authorized Lincoln sales and service representative, contact:

Americas:

St. Louis, Missouri
Phone +1 314.679.4200
Fax +1 800.424.5359
www.lincolnindustrial.com
Where to buy

Europe/Middle East/Africa:

Walldorf, Germany
Phone + 49.6227.33.0
Fax + 49.6227.33.259
www.lincolnindustrial.de
CONTACTS

Asia/Pacific:

Singapore
Phone + 65.65880188
Fax + 65.65883488



Lincoln GmbH
Heinrich-Hertz-Str. 2-8
D-69190 Walldorf · Germany
Phone + 49.6227.33.0
Fax + 49.6227.33.259

lincoln@lincolnindustrial.de
www.lincolnindustrial.de
© Copyright 2009
Printed in Germany
Form W-115-En-0609

DIN EN ISO 9001
durch DQS
Reg.-Nr. 799

DIN EN ISO 14001
durch GUT